

## Installation Instructions for the S-500 Renlita Door

---

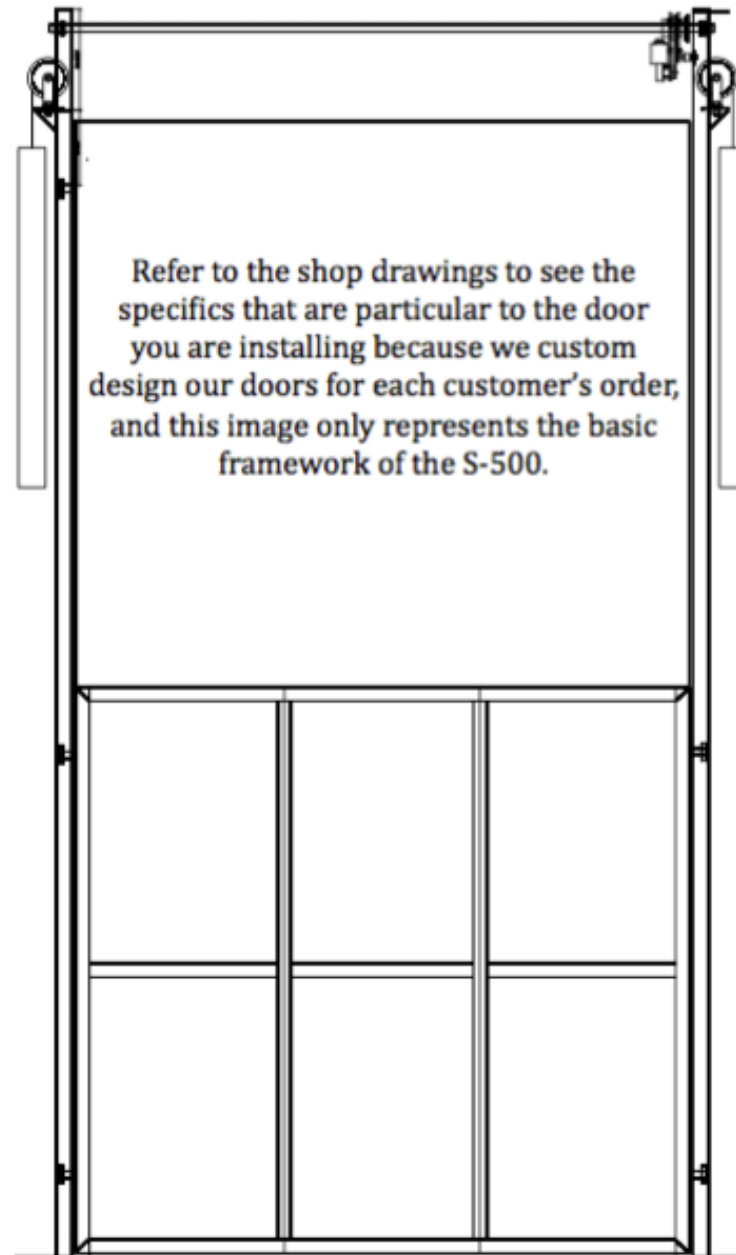

# Table of Contents

Process 1- Preparations .....1

Bring these tools and materials

Examine the area Set up a work zone Prepare the pieces

Process 2- Positioning the Door.....2

Set the door inside

Connect the cables Raise the door

Process 3- Fastening the Operating Channels.....3

Place the operating channels

Route the cables

Align the door

Fasten the operating channels

Process 4- Installing the Glass.....5

Apply the tape and seat the glass panels

Insert the glazing caps

Process 5- Hanging the Counterweights and Balancing the Door.....7

Hang the weights Balance the door

Process 6- Engaging the Motor to the Door .....8

Connect the door to the trolleys

Install the torsion bar

Process 7- Installing the Threshold and the Top and Bottom Seals.....9

Install the top seal Install the threshold Install the bottom seal

Process 8- Programming the Motor and Covering the Counterweights ..... 11

Install and program the motor Test the door

Cover the counterweights

Troubleshooting ..... 12

Service and Repair..... 13

Replacing a glass panel Replacing the trolley bearings

## What you need to know before you begin:

- Only factory trained installers may install Renlita doors because only they have the training to install them correctly, which is critical for quality and safety.
- Make sure you obtain and follow the shop drawings in each shipment because they alone specify each door's particular configuration. Do not begin an installation without them.
- Never substitute the hardware and components that Renlita Doors provides. If you need new parts, contact Renlita at the number below.
- Use the appropriate tools, equipment, and personal protective gear to install the door so that you ensure a safe and quality installation.
- Contact Renlita if you need technical support: 903-583-7500

## Process 1- Preparations

### 1 Bring these tools and materials

- A. Tape measure
- B. Slip-ring pliers
- C. Rubber mallet
- D. Pull-type chain hoist
- E. Power drill and drill bits- (Phillips, flat-head, sockets, etc.)
- F. Laser level or a long level (A laser level works best.)
- G. Sockets and wrenches
- H. Utility knife or sheers
- I. Wooden shims
- J. Thread-locking compound
- K. Heavy duty C-clamps
- L. Glazing suction cups

### 2 Examine the area

A. Compare the shop drawings to the doorway to ensure it has these things:

- a. A finished-floor height that matches the drawings
- b. Space for the door to open and close without hitting the floor or the ceiling's furnishings
- c. Space in the doorway for the door
- d. Space for the counterweights to move without contacting other things
- e. Space for the cables to run without rubbing anything
- f. Space on the doorjamb and at the ceiling for the operating channels
- g. Doorjamb that are the same material as those in the shop drawings

### 3 Set up a work zone

A. Let other construction workers in the area know that the doorway will be inaccessible from the time you begin until you complete your installation. No one should run hoses or cords through the doorway because you will need total clearance.

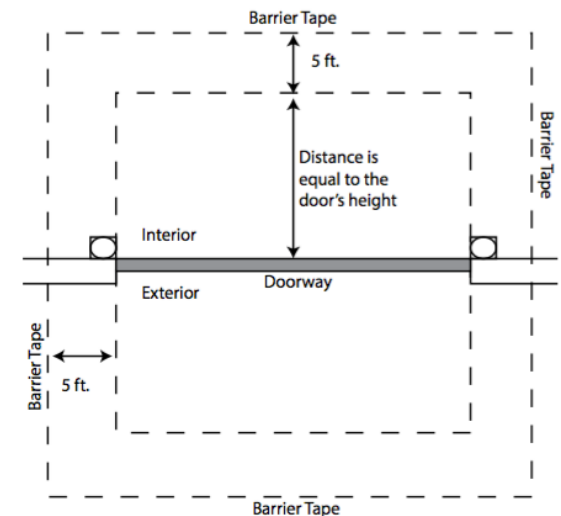

B. Set up a safety zone according to the illustration.

#### 4 Prepare the pieces

- A. Thoroughly examine the cables to make sure they are in good condition. Do not install them if they have any damage.
- B. Contact Renlita if you need a replacement cable.
- C. Place the counterweights and the operating channels inside the doorway.
- D. Place the glass panels and glazing caps out of the way, if you any, to protect them from damage.
- E. Insert the side seals into the operating channels.



## *Process 2- Positioning the Door*

### *1* Set the door inside

- A. Lay the door flat on the ground inside the doorway because the axles need to be on the inside when you raise it into position.
- B. Set the door on a soft material so that you will not accidentally mar the finish. Cardboard or plywood works well for this.

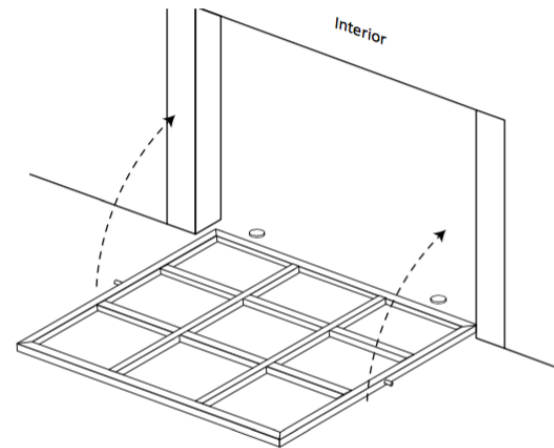

### *2* Connect the cables

A. Lubricate the top axle and bottom axle with the lubricant in the shipment; then join the cables, rollers, and slip rings to the top and bottom axles by following the sequence shown:

TOP AXLE CABLE ORIENTATION

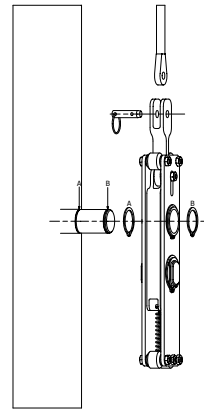

BOTTOM AXLE CABLE ORIENTATION

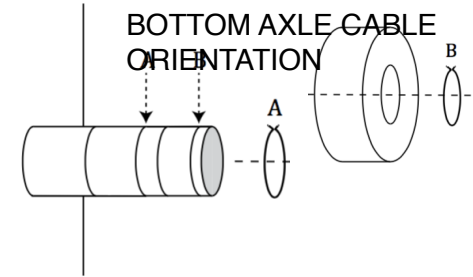

### 3 Raise the door

- A. Raise the door into the doorway, and refer to the shop drawings to know how high off the finished floor it needs to be.
  
- B. Use a chain hoist or a forklift to raise the door into position within the frame. Make sure to use a padding material to protect the finish on the door from the chain or the lift's arms.

\* CAUTION: Ensure that the hoist or the forklift is rated to lift the door's weight.

## *Process 3- Fastening the Operating Channels*

### 1 Align the door

A. Install the door to the specific dimensions on the shop drawings, even if the floor is not finished.

\* All dimensions in the shop drawings show the door's position relative to the finished floor.

B. Center the door so that it has equal spacing on the right and left.

C. Level the door with a leveling device and shims.

D. The space between the bottom of the door and the finished floor must at least be what you see in the shop drawings.

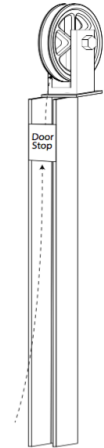

## 2 Place the operating channels

A. Position the operating channels according to the shop drawings, and use a laser level or a plumb bob to make sure they are vertically plumb.

\* You may need to place shims between the operating channels and the doorjamb in order to keep the channels vertically plumb.

B. Make sure the side seals on the operating channels are touching the door so that no light can shine through, but not so hard against it that the seals are compressed.

C. Adjust the operating channels, not the door, if the seals allow light to shine through.

D. Measure the distance between the channels at the bottom, middle, and top to ensure they are evenly spaced because the door will not operate smoothly if they are unevenly spaced. Clamp or tack weld the channels to keep them in place as you align them.

a. The shop drawings may show the measurements between the operating channels for you to match.

b. If they do not, the space between the operating channels will be the same as the



A. Ensure that the operating channels are evenly spaced and vertically plumb from top to bottom.

B. Use the hardware in the shipment to permanently mount the operating channels onto the doorjamb according to the shop drawings. Make sure the channels remain plumb as you fasten each set of fingers to the doorjamb.

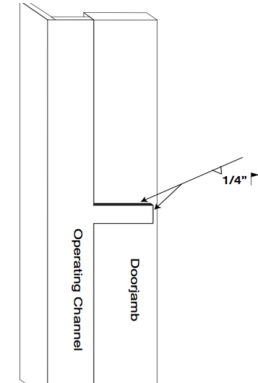

C. These illustrations show the standard methods for fastening the operating channels to wooden, steel, and concrete doorjamb. Refer to the shop drawings to know which applies to your installation.

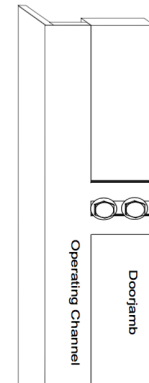

For wooden doorjamb-

Install the lag screws from the shipment according to this illustration; we will send washers in the shipment if the lag screws need them.

For steel doorjamb-

Weld the top and side edges, and make the welds at least 1/4" thick.

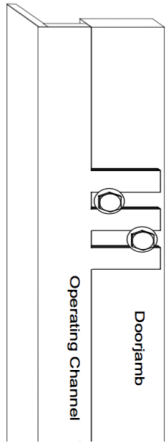

For concrete doorjambs-

Install the anchors from the shipment according to this illustration; we will send washers in the shipment if the anchors need them.

### ***Process 4- Installing the Glass (For doors with cladding, skip to Process 5)***

1 Apply the tape and seat the glass panels

\* NOTE: Only install the glass in dry weather and in temperatures above 40° Fahrenheit, or the tape will not adhere to the glass or the door.

A. Thoroughly wipe the areas where the tape will lie with denatured alcohol so that dust and moisture do not inhibit the tape's adhesiveness.

\* NOTE: Do not substitute another adhesive in place of the tape in the shipment, unless the shop drawings indicate otherwise.

B. Apply the double-sided glazing tape to the inner edges of the mullions and to the frame where the panels will sit. Leave the protective film on the tape until you're ready to seat the panels. Do not lay the tape on a dirty surface because it will pick up dust, which inhibits its adhesiveness.

C. Splices in the tape make the glass less likely to stick, so only splice the horizontal strips of tape where the mullions meet the frame and where the vertical cap grooves meet the mullions. (See the illustration.)

D. Apply the sealant in the shipment (Dow Corning 995 Sealant) to every splice in the tape, and place a setting block where each corner of the glass panels will sit.

E. Refer to the shop drawings to know which side of the glass should face the exterior.

F. Use suction cups to carry the glass panels, and

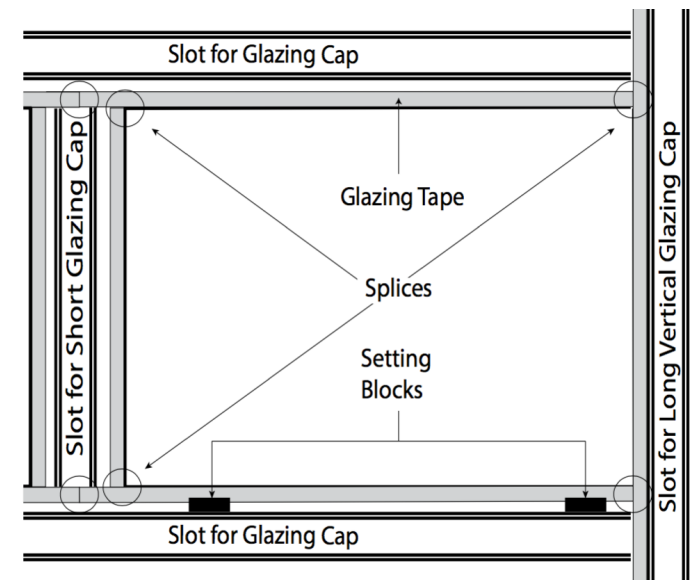



seat them on the setting blocks. Press them firmly against the tape; the tape will adhere to the glass instantly.

G. Install the short glazing caps between the panels you have seated to hold them in place as you seat the others.

\* NOTE: Make sure your suction cups are rated to carry the weight of the glass panels.

## 2 Insert the glazing caps

A. Before you set a cap, trim the ends of its seals at a 45° angle so that it will not push up the seal of the cap that it intersects. (See the illustration on the side.)

\* NOTE: Do not trim the caps because they have been fitted in the factory.

B. Cut a gap in the seals of the long, horizontal caps where the shorter caps will intersect them. Cut a similar gap in the seals of the long, vertical caps where the long, horizontal caps will intersect them.

(See the circles in the illustration below.)

- C. Cut the seals of the outer caps flush at the caps' ends. (See the thick dotted line in the illustration below.)
- D. Affix the caps by aligning their grooves to the inside of the mullions' grooves and tapping them in place with a rubber mallet. The caps will have labels to indicate their place on the door.

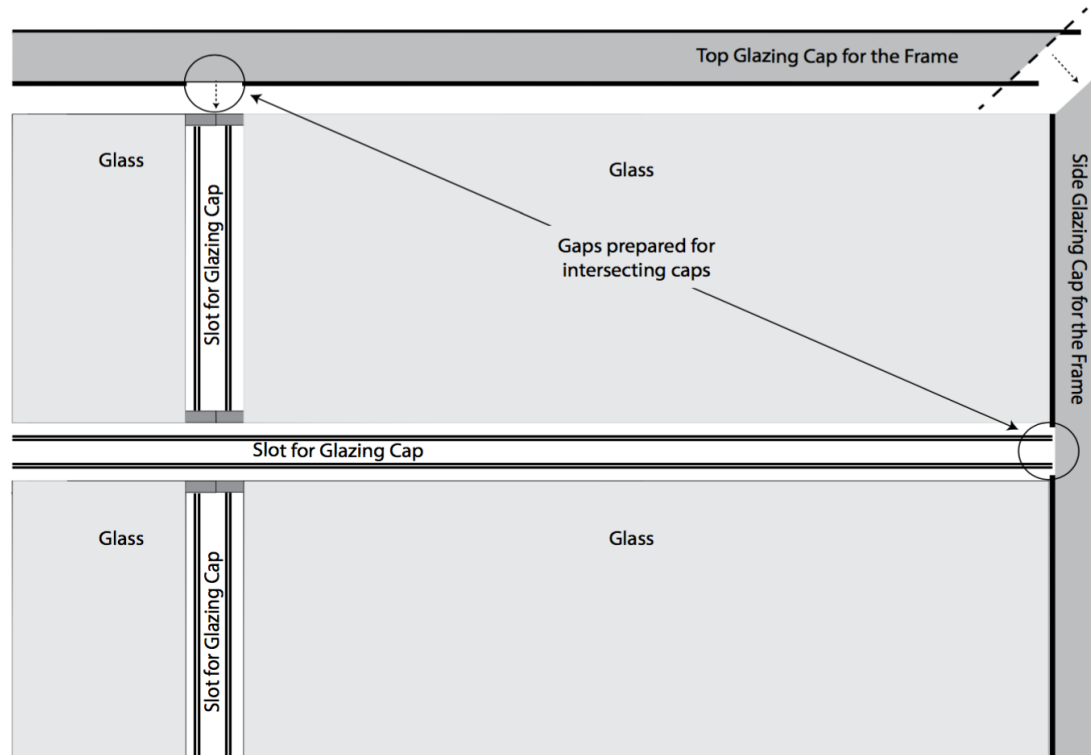
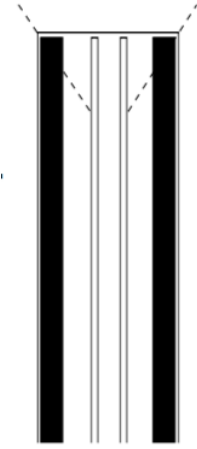

## Process 5- Hanging the Counterweights and Balancing the Door

### 1 Hang the weights

\* CAUTION: You must install the glass (or cladding) before you hang the counterweights because they have been calibrated to offset the weight of the door with its glass or cladding.

- A. Refer to the shop drawings to ensure that you hang the weights properly.
- B. Properly align the pulleys over the operating channels so that the cables do not rub anything after you hang the weights.
- C. Use a chain hoist or a forklift to raise the counterweights to the cables.
- D. Always bring the counterweights up to the cables, leaving the door closed. Never try to bring the cables down to the weights by opening the door.

\* Welding a temporary lug on each of the weights gives your chain or strap something to catch as you raise the weights.

\* When hanging a shared counterweight, hang it in the middle of the shared cable, according to the shop drawings.

## 2 Balance the door

A. Check the balance of the door by opening it halfway to see if it suspends without being inclined to open or close on its own. a. If the door closes on its own, the counterweights are not

heavy enough, and you need to weld on extra plates.

\* NOTE: You must ground your welder directly to the counterweight so that the electrical current does not run through the cable and melt its core.

b. If the door opens on its own, the counterweights are too heavy.

c. Also, the door is balanced if you can open and close it with the same amount of pressure.

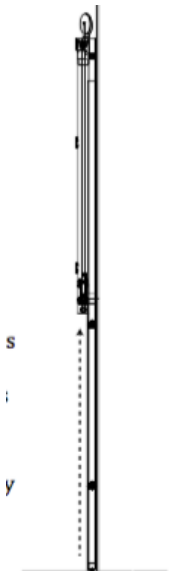

- B. Fully open and close the door to make sure nothing hinders the counterweights or the door's travel. Fix any obstructions before you proceed.
  
- C. To open the door manually, lift the bottom, and slowly guide it upward until it gently rests in its open position. Close the door by gently pulling the bottom down until the door closes fully.

\* NOTE: Be careful not to allow the door to slam open or shut because that will eventually cause damage to the door, which may make it dangerous to use.

### ***Process 6- Engaging the Motor to the Door (For manual doors, skip to process 7)***

#### **1 Connect the door to the trolleys**

A. Insert the pins through the door's lugs into the pin sleeves of the trolleys, and secure them with the cotter pins. (See the illustration to the right.)

\* Your door's lugs may look different from the picture.

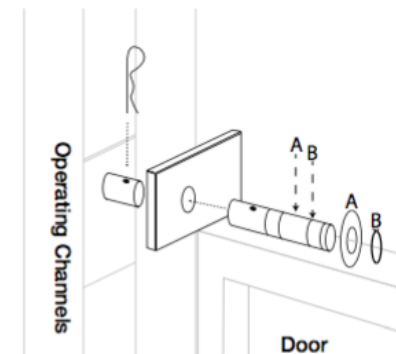

## 2 Install the torsion bar

- A. Check the shop drawings to see its specifications for placing the motor and installing the torsion bar.
- B. Cut the torsion bar to fit between the axles on the inner sides of the operating channels. (See the dotted line.)
- C. Use the adjustment coupler and the fixed coupler to attach the bar to the axles; then install the center support bracket according to the shop drawings. Level the bar before you secure it.

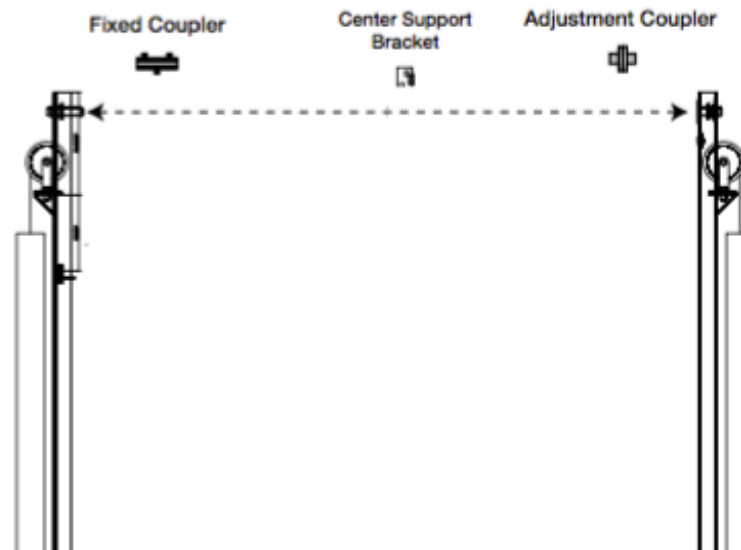

## Process 7- Installing the Threshold and the Top and Bottom Seals

### 1 Install the top seal

A. Refer to the shop drawings for the details on installing the top seal.

### 2 Install the bottom seal

A. Open the door to access the bottom of the frame, and install the seal according to the drawings below. Seat the screws approximately 12 inches apart.

B. The drip edge of the gasket should face the exterior side.

Attaching the first set of screws-

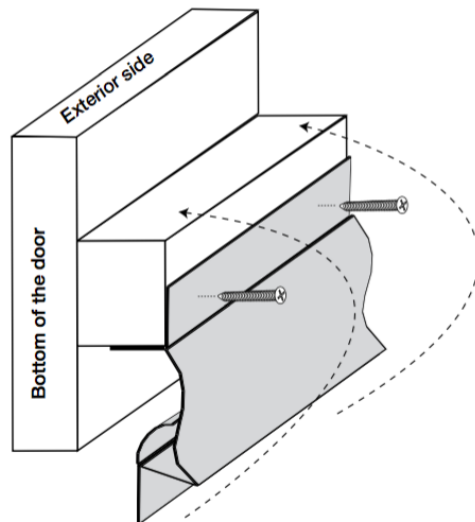

Attaching the second set of screws-

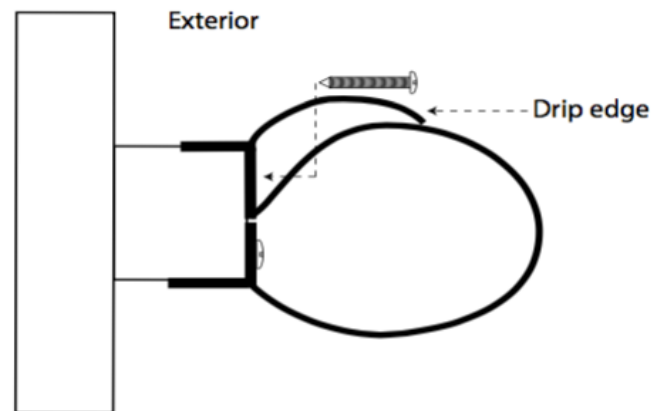

### 3 Install the Threshold

- A. Measure the opening between the jambs, and cut the threshold 3 inches longer than the opening.
- B. Cut a 1 1/2 inch notch out of the short side on the ends of the threshold. (See the illustration.)

- C. Seat the notches of the threshold on the outer corners of the doorjambs, and operate the door to make sure the bottom seal and the hump on the threshold make good contact without inhibiting the door's movement.

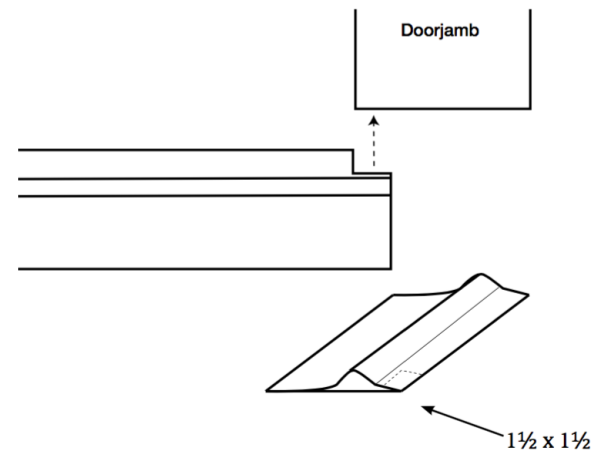

- C. Drill pilot holes in the floor for the screws through each of the predrilled holes in the threshold. Move the threshold, and apply a bead of structural adhesive that is 5/16 of an inch thick between the pilot holes where the threshold will lie.



D. Place the threshold in its position, and seat the screws.

\* NOTE: If you need to splice the threshold, join the pieces where screws will be no more than 8 inches from both sides of the splice.

## ***Process 8- Programming the Motor and Covering the Counterweights***

### **1 Install and program the motor**

- A. Install the motor as the shop drawings specify.
- B. Program the motor according to its installation manual.
- C. Ensure that the motor closes the door vertically plumb.

### **2 Cover the counterweights**

A. Follow the shop drawings to see how to install the covers for the counterweights.

### 3 Test the door

A. Operate the door 5 to 10 times to ensure it works properly.

B. Ensure that the seals are making good contact and that the door closes and opens to the dimensions in the shop drawings.

### *Troubleshooting*

A. The door is difficult to open or close.

a. Make sure the axles are not rubbing the back walls of the operating channels.

b. Ensure the perimeter seals are not inhibiting the door's travel.

c. Check the balance of the door and the counterweights; add or remove weight from the counterweights if it's necessary.

- d. Ensure that the counterweights can travel without contacting anything.
- B. The door stops and returns to the open position when I try to close it.
- a. Make sure that nothing is obstructing the motor's safety sensors.
  - b. Check the motor's control panel because it may indicate the problem. Refer to the motor's installation manual for a diagnosis.
  - c. Make sure the wiring in the control station is correct.
- C. The door will not operate.
- a. Verify that power is getting to the motor and/or its control unit.
  - b. Check the wiring in the control station.
  - c. Make sure the photo eyes are connected and working properly.
  - d. Make sure the motor is engaged to the torsion bar.

D. The door makes a “bumping” noise when I operate it.

- a. Lubricate the surfaces between the cable thimbles and the axles with bearing grease.
- b. Make sure the trolley chains have a little deflection in them. Adjust each chain’s tension by turning the nuts on the bolt that connects the trolley to the chain.
- c. Inspect and lubricate the pulley bearings.

E. The door does not close completely.

- a. Check the settings for the travel limit that the motor calibrated.

F. The door does not open completely

- a. Check the door stops to make sure the door is meeting them and opening fully.  
(See the illustration in Process 3, Step 2 to help you locate the door stops.)
- b. Make sure the door is not colliding into the lintel.
- c. Make sure nothing is keeping the counterweights from lowering fully.

G. ZAP Motor is operating very slow.

- a. The motor may still be calibrating the door's movement. Refer to the motor's manual for reset instructions and limit programming.
- b. Make sure nothing is obstructing the door.
- c. In the event of power loss for more than 2 hours, the internal memory module will need to recalibrate the door's limits. Operate the door to fully open and fully closed, and the motor will resume normal operation.

## *Service and Repair*

### 1 Replacing a glass panel

- a. One person should hold the panel on the outside with suction cups.
- b. From the inside, another person should cut the double-sided tape by sliding a utility knife around the edges of the panel, releasing it for the person on the outside to remove.

- c. Thoroughly clean the tape area with alcohol, scraping the excess residue if it's necessary. Do the same on the glass panel if you intend to reuse it.
- d. Reapply the tape according to the instructions in Process 4.

## 2 Replacing Slides

- a. Slide the trolley down to the service port, which is just above the door when it's closed.
- b. Disconnect the trolley from the chain by unscrewing the tensioner bolt at the bottom and unhinging the chain link at the top. Removing the U-shaped fastener from the chain link allows you to slide the chain pin out of the trolley's tab.

(See the illustration.)

- c. Pull the trolley out at the bottom of the channel.
- d. Remove the screws and install new ones on each side

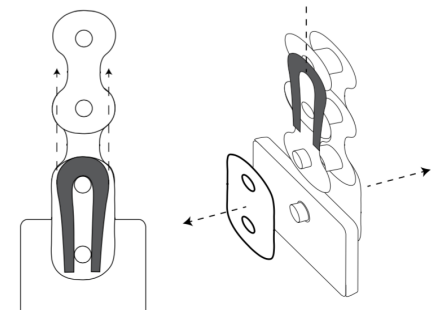

- e. Reinsert the trolley into the channel, and reconnect the tensioner bolt and the chain link.

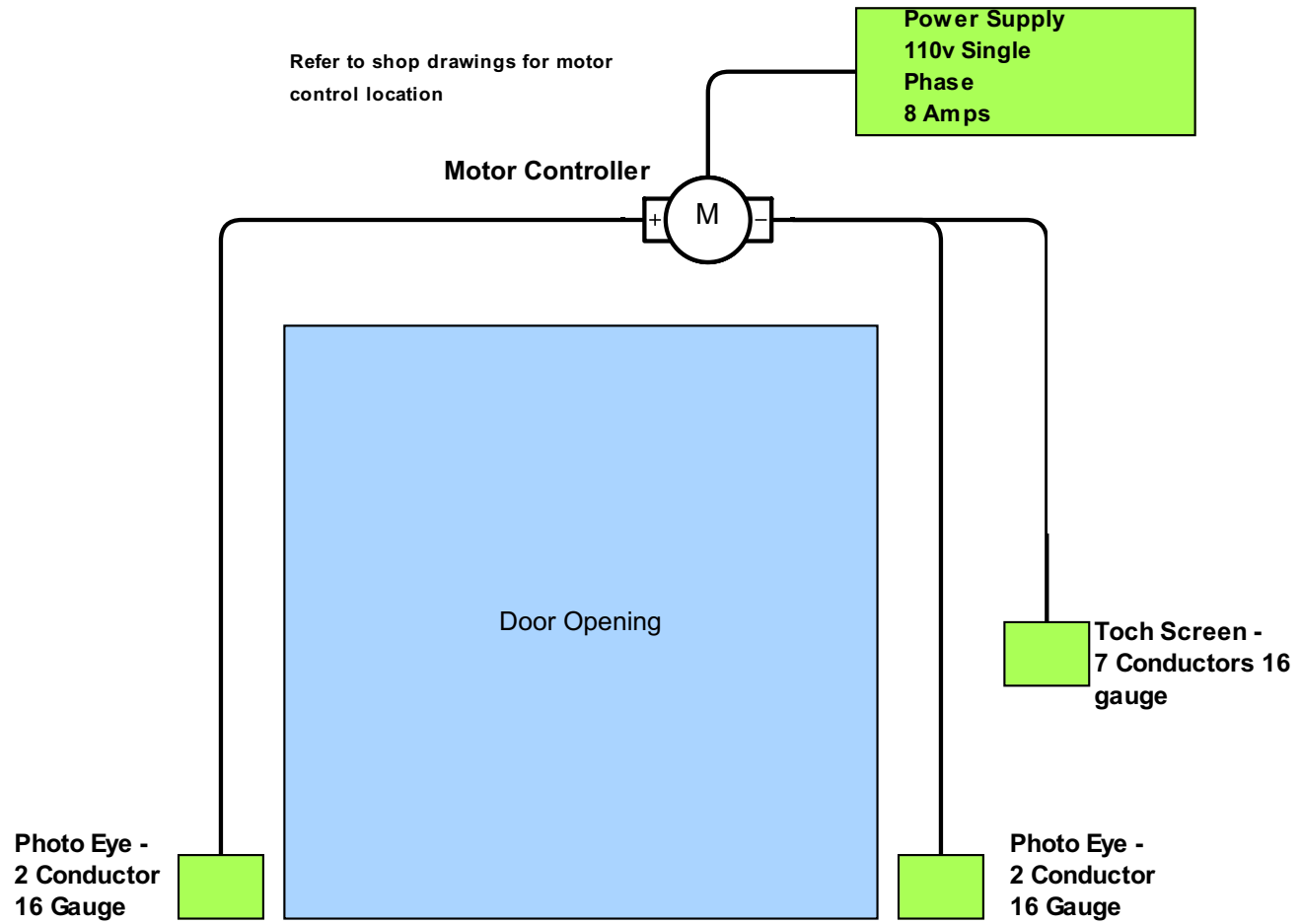



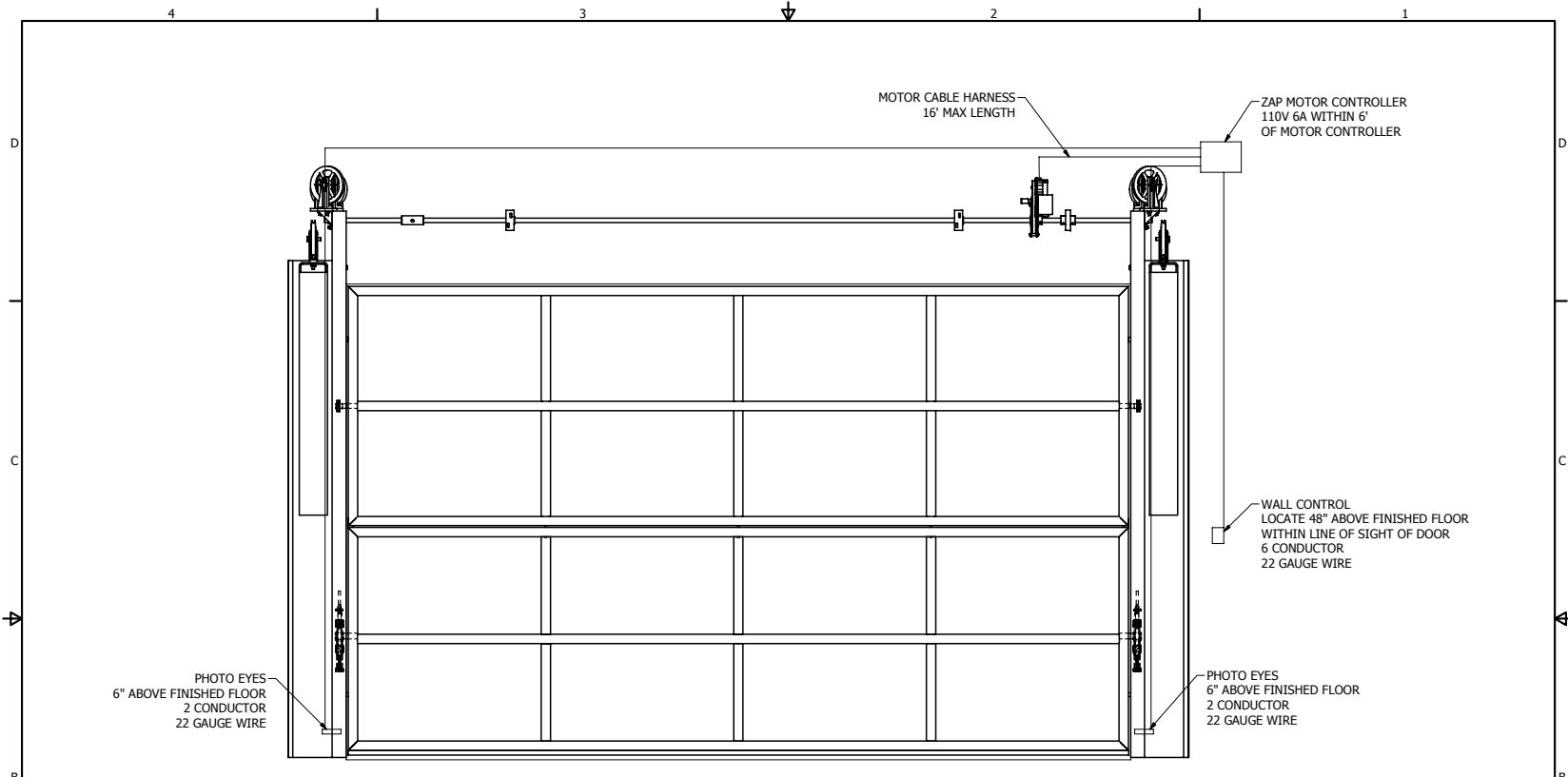

ELECTRICAL COORDINATION

UNLESS OTHERWISE SPECIFIED  
DIMENSIONS ARE IN INCHES.

TOLERANCES

X=±.050  
.XX=±.015  
XXX=±.005  
ANGULAR ±.5°

DRAWN		RENLITA	
CHECKED		TITLE	
QA		ELECTRICAL COORDINATION	
MFG		SIZE	DWG NO
APPROVED		C	
		SCALE 1:1	SHEET 1 OF 1
		REV	1

## Renlita Touchpad Door Controller Keypad Operation

When the Keypad Enable jumper is installed and the system is in idle (main logo displayed) pressing anywhere on the screen will bring up a 10 key pad for entering a security code.

When the security code has been entered, then press the ENTER key. If the code is correct, the door control screen will show. If the code is incorrect, the unit will beep and the code may be entered again.

If the keypad is showing and a key is not pressed for 20 seconds, the system will revert back to the idle screen.

The default factory code is the lower 4 digits of the serial number.

Whenever the default factory code is entered, the user will be asked if they would like to set a passcode. This will always be the case, even if a user code has been entered.

Pressing NO will proceed to the door control screen.

Pressing YES will show the 10-key pad. The user will then enter a code, up to 4 digits, and press Enter. Then a confirmation screen will ask to accept or cancel the new code.

ACCEPT will save the new passcode.

CANCEL will proceed to the door control screen without saving a code.

When the user wishes to change the code, enter the factory default code and repeat the process.

**Important:** the user code can be up to 4 digits, but 0000 is not acceptable. Any leading zeros will be ignored.

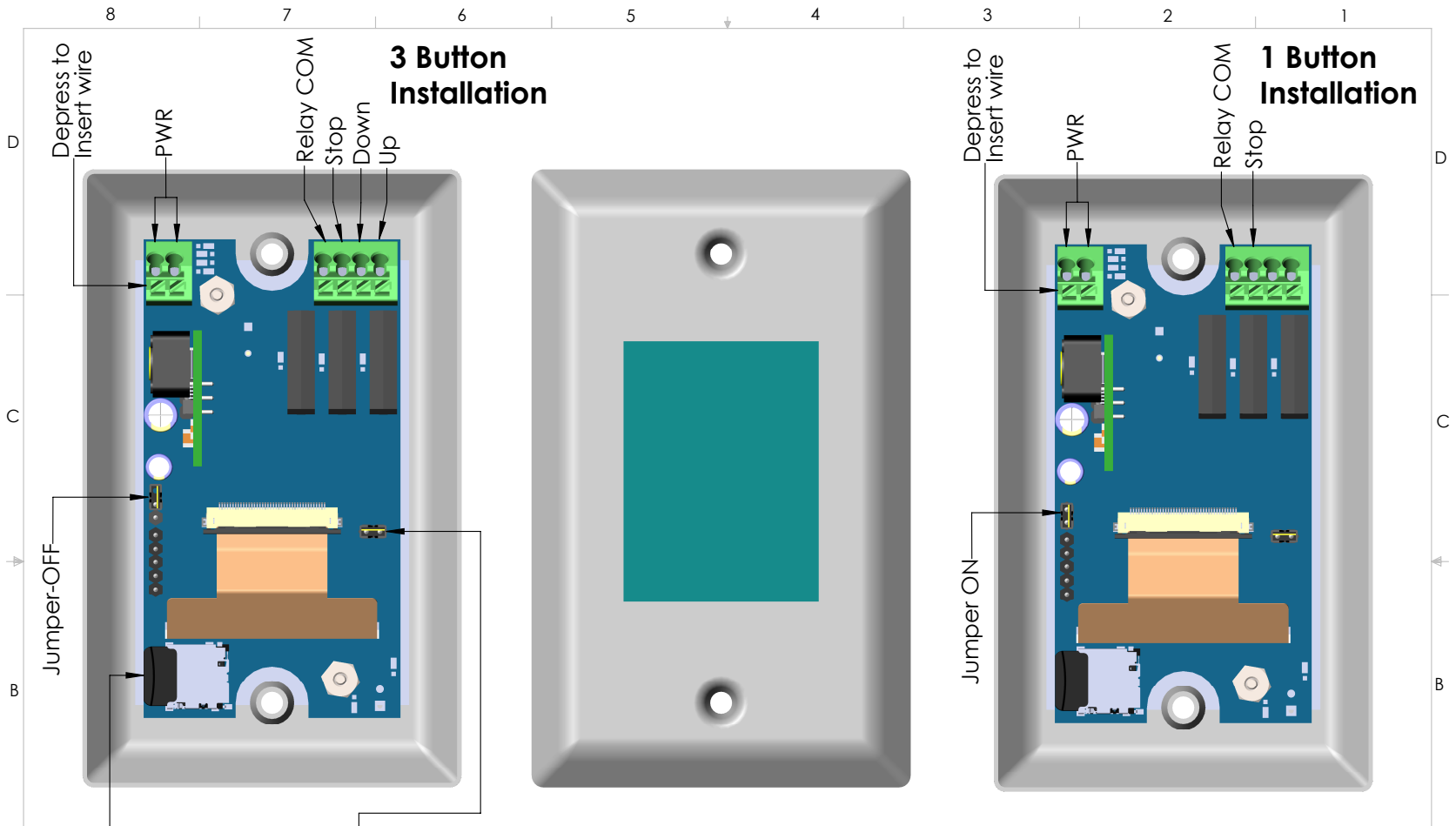

Micro SD Card  
Graphic Storage

Jumper ON  
Number Pad Enabled  
Jumper OFF  
Number Pad Disabled

DATE	REV.	DESCRIPTION	ECO #	ENG.	APPROVED
07/22/15	A	ORIGINAL RELEASE	1001366	BH	
08/26/15	B	Number Pad and SD Card Added	1001366	BH	
09/29/15	C	1Button and 3 Button Call out	1001366	BH	
00/00/15	D	4th RELEASE	1001xxx	BH	

THE INFORMATION CONTAINED IN THIS DRAWING IS THE SOLE PROPERTY OF APPLIED DIGITAL, INC. ANY REPRODUCTION IN PART OR WHOLE WITHOUT THE WRITTEN PERMISSION OF APPLIED DIGITAL, INC. IS PROHIBITED.

ITEM NO.	PART OR IDENTIFYING NO.	NOMENCLATURE OR DESCRIPTION	MATERIAL SPECIFICATION	QTY REQD
PARTS LIST				
UNLESS OTHERWISE SPECIFIED DIMENSIONS ARE IN INCHES TOLERANCES ARE: FRACTIONS DECIMALS ANGLES + .XX+ .XX + 1 .XXX+.XXX		CAD GENERATED DRAWING. DO NOT MANUALLY UPDATE	<b>Applied Digital, Inc.</b>  <b>99917000007</b> <b>Garage Door Opener</b>	
APPROVALS		DATE		
DRAWN	BH	09/29/15		
CHECKED				
MATERIAL		RESP ENG		
FINISH		MFG ENG		
DO NOT SCALE DRAWING		QUAL ENG		
SIZE A		DWG. NO. 1839	REV. C	
SCALE		CAD FILE:	SHEET 1 OF 1	

